

Data Sheet



Article number: 204250M1675D3U

Description: E+G levelling foot
GN 42-50-M16-75-D3-U

Note: U Without nut, Hexagon socket at the top, Wrench flat at the bottom

Measures

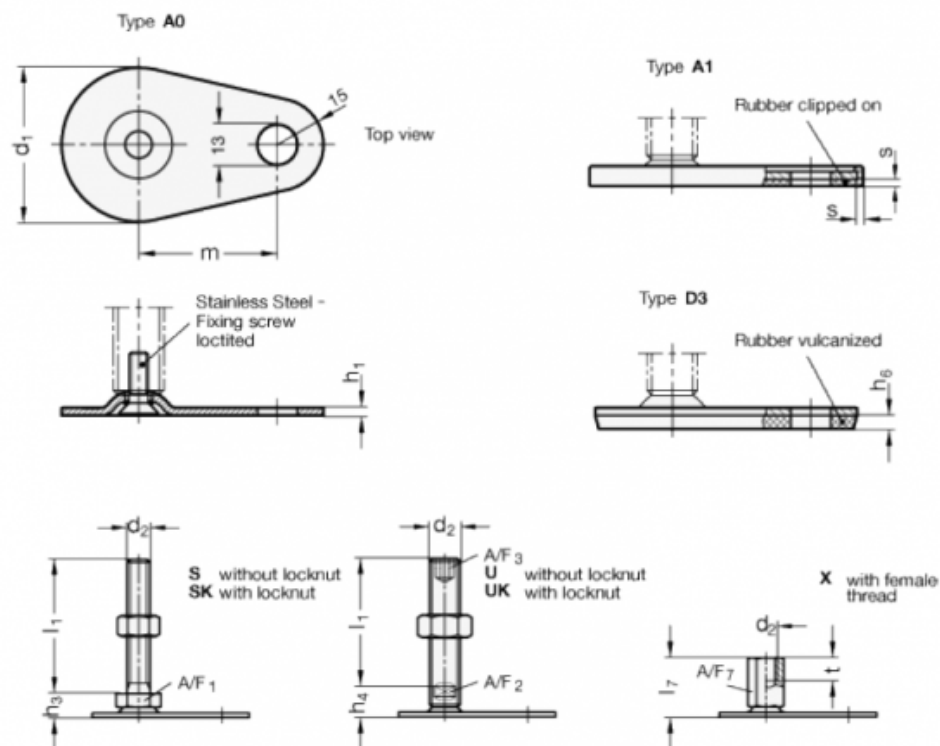

A/F2 = 12	m = 45
A/F3 = 8	s =
d1 = 50	
d2 = M16	
h1 = 2.5	
h4 = 17	
h6 = 4	
l1 = 75	